

STANDARD GROUND STEEL PLATES - PLAQUES STANDARD RECTIFIÉES - PLACAS ESTANDAR DE ACERO RECTIFICADAS

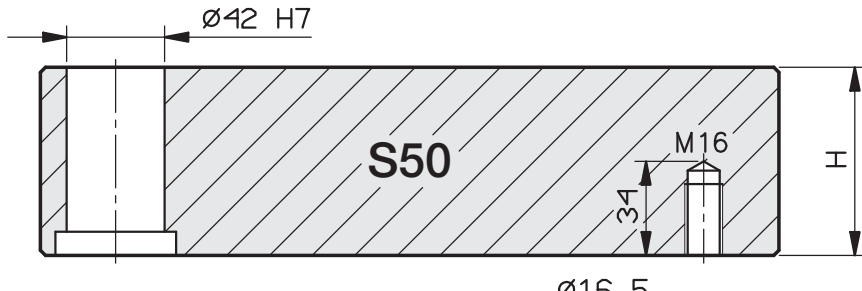

46	1730-2311-2312-2738
56	
66	
76	
86	
96	
116	
136	
156	
176	



46	1730-2312
56	
66	
76	
86	
96	
116	
136	

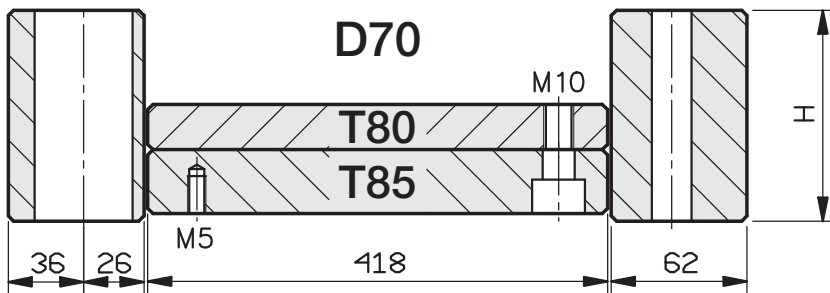

96	1730
116	
136	
156	
27	1730
36	

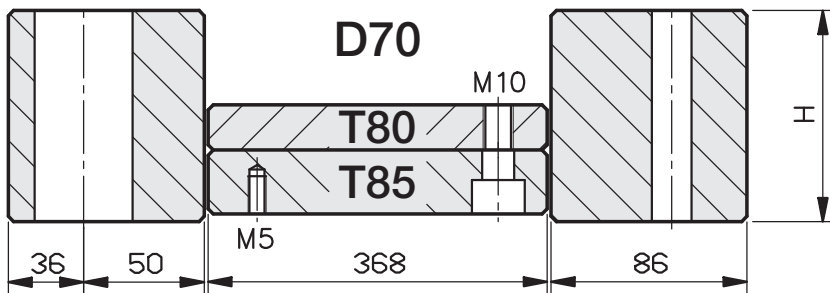

96	1730
116	
136	
156	
27	1730
36	

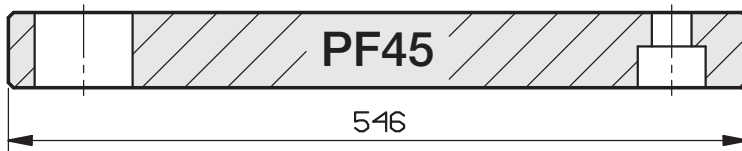

46	1730
----	------

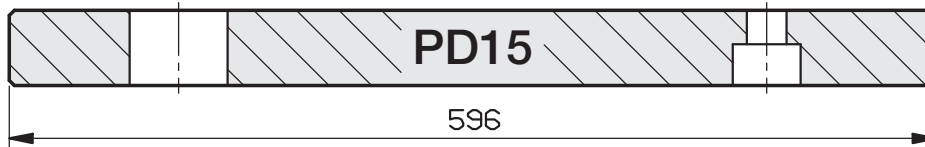

46	1730
----	------

GUIDED EJECTOR PLATES ON REQUEST - PLAQUES D'ÉJECTEUR GUIDÉES, SUR DEMANDE - PLACAS DE EYECCIÓN GUIADAS, BAJO PEDIDO

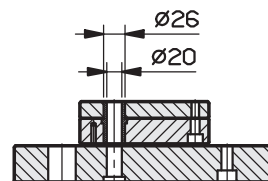
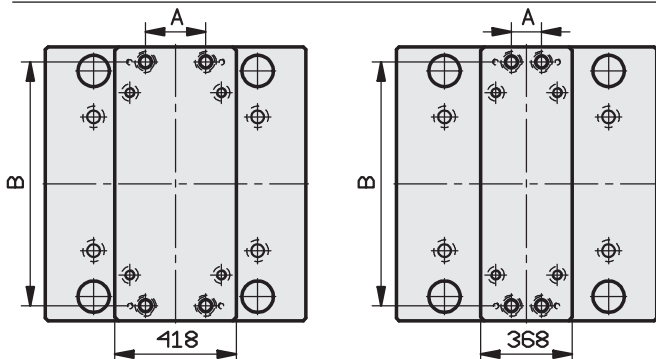

SERIES - SERIES SERIE	A	B
546x546 - 418	310	508
546x546 - 368	260	508

546 x 546

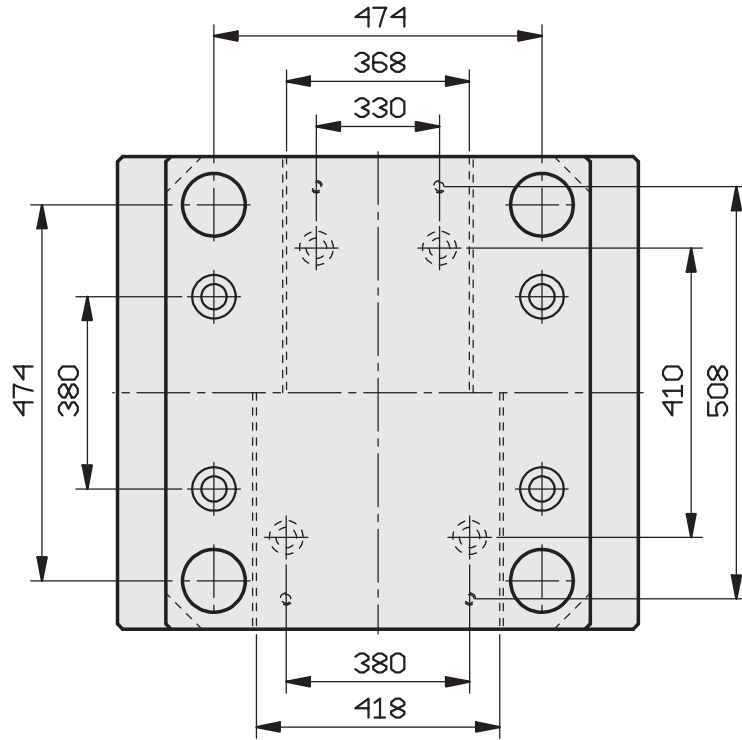

STANDARD GROUND STEEL PLATES - PLAQUES STANDARD RECTIFIÉES - PLACAS ESTANDAR DE ACERO RECTIFICADAS

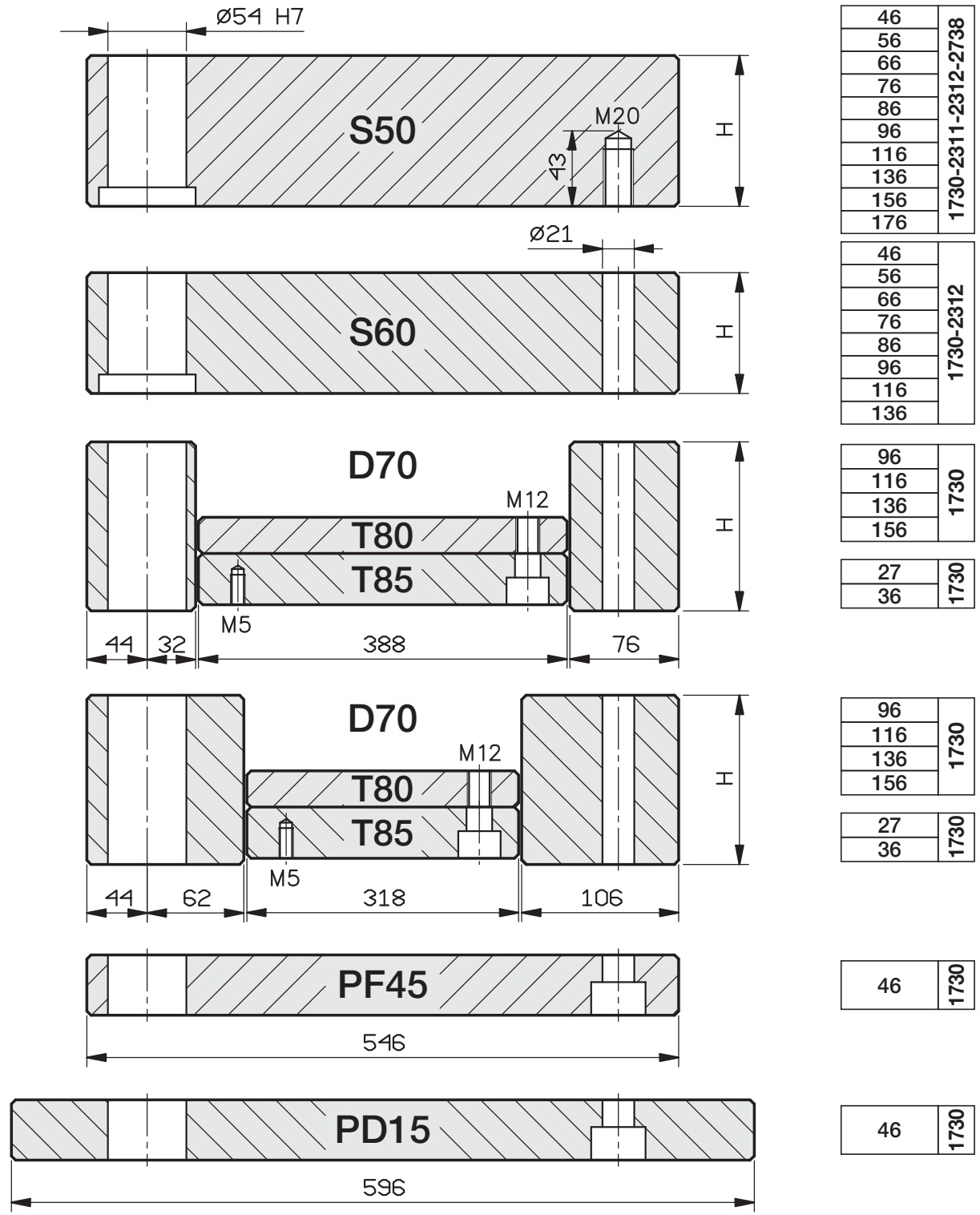

GUIDED EJECTOR PLATES ON REQUEST - PLAQUES D'ÉJECTEUR GUIDÉES, SUR DEMANDE - PLACAS DE EYECCIÓN GUIADAS, BAJO PEDIDO

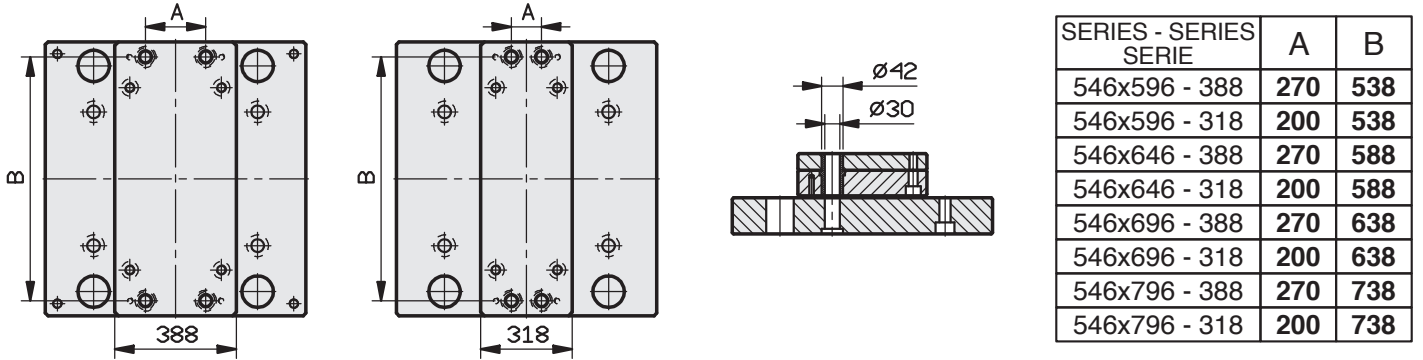

546 x 596

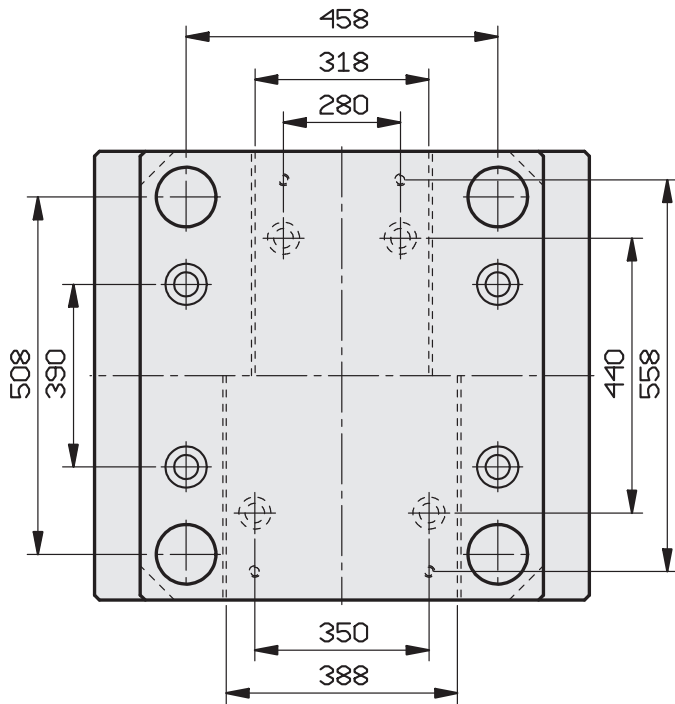

546 x 646

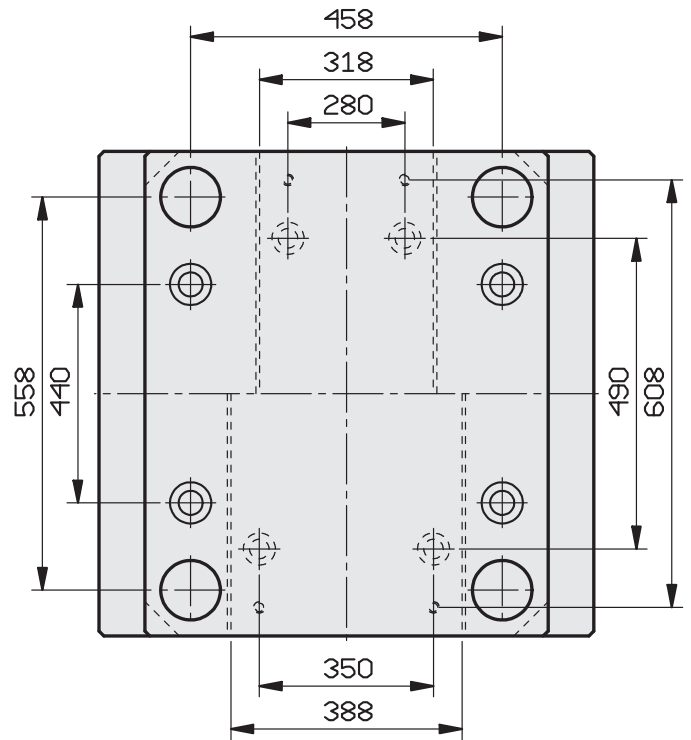

546 x 696

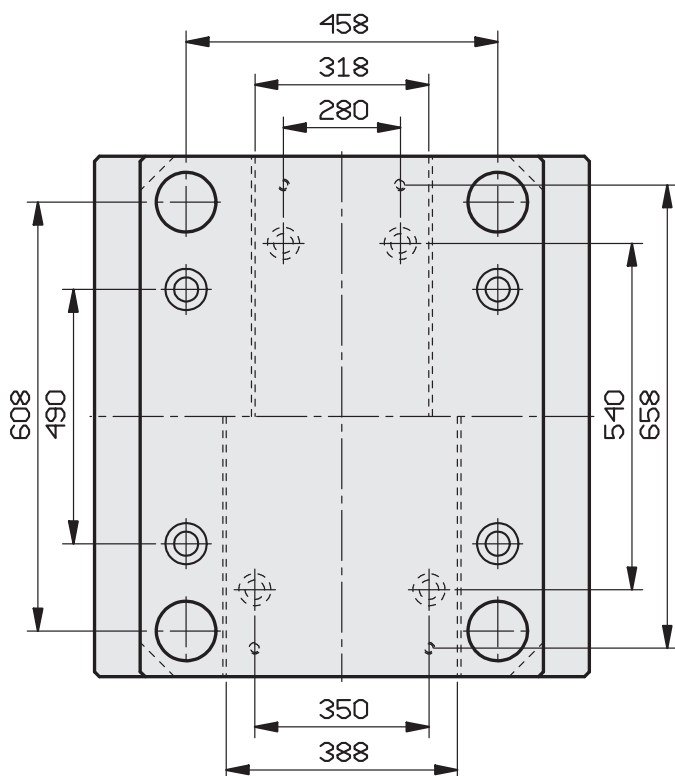

546 x 796

